

International Association Of Certified Practicing Engineers	 www.iacpe.com Setting The Standard	Page : 1 of 80
		Rev: 01
		Rev. 01- August 2014
IACPE No 19, Jalan Bilal Mahmood 80100 Johor Bahru Malaysia	INSTRUMENTATION CONTROL VALVE SIZING AND MATERIAL SELECTION CPE LEVEL II TRAINING MODULE	

The International Association of Certified Practicing Engineers is providing the introduction to the Training Module for your review.

We believe you should consider joining our Association and becoming a Certified Practicing Engineer. This would be a great option for engineering improvement, certification and networking.

This would help your career by

1. Providing a standard of professional competence in the practicing engineering and management field
2. Identify and recognize those individuals who, by studying and passing an examination, meets the standards of the organization
3. Encourage practicing engineers and management professionals to participate in a continuing program of personal and professional development

www.IACPE.com

International Association Of Certified Practicing Engineers	INSTRUMENTATION CONTROL VALVE SIZING AND MATERIAL SELECTION CPE LEVLE II TRAINING MODULE	Page 2 of 80
		Rev: 01
		August 2014

TABLE OF CONTENT

INTRODUCTION

Scope	6
General Design Consideration	8
<i>I. Control Valve Body</i>	8
<i>A. Linear Motion</i>	8
1. <i>Single Port Valve Body</i>	8
1.1 <i>Conventional Single Seat</i>	10
2. <i>Double Port Valve Body</i>	10
2.1 <i>Conventional Double Seat</i>	11
3. <i>Three Way Valve Body</i>	12
<i>B. Rotary Motion</i>	14
1. <i>Butterfly Valve</i>	14
<i>II. Control Valve Actuator</i>	16
<i>I) Diaphragm Actuators</i>	19
<i>II) Piston Actuators</i>	19
<i>III) Electro Hydraulic Actuators</i>	20
<i>IV) Manual Actuators</i>	20
 DEFINITIONS	 21
 NOMENCLATURE	 25

International Association Of Certified Practicing Engineers	INSTRUMENTATION CONTROL VALVE SIZING AND MATERIAL SELECTION	Page 3 of 80
		Rev: 01
	CPE LEVLE II TRAINING MODULE	August 2014

THEORY OF THE DESIGN	27
A) Control Valve Flow Characteristic	27
I) Inherent Flow Characteristic	27
II) Linear Flow Characteristic	29
III) Equal Percentage Flow Characteristic	29
IV) Quick Opening Flow Characteristic	30
V) Installed Flow Characteristic	31
B) Control Valve Sizing	32
I) Sizing for Liquid Services	33
<i>Pressure Drop Across Control Valve</i>	37
<i>Flashing and Cavitation</i>	37
<i>Choked Flow</i>	40
<i>Computing $\Delta P_{critical}$ and Geometry Factors</i>	41
<i>Flow Correction Factor (F_R)</i>	44
<i>Other method</i>	46
II) Sizing for Vapor Services	47
<i>Critical Pressure Drop</i>	49
<i>Calculating the Valve Flow Coefficient</i>	49

International Association Of Certified Practicing Engineers	INSTRUMENTATION CONTROL VALVE SIZING AND MATERIAL SELECTION	Page 4 of 80
		Rev: 01
		August 2014
CPE LEVLE II TRAINING MODULE		

APPLICATION	51
Example Case 1: Sizing a Control Valve in Liquid Hydrocarbon Application	51
Example Case 2: Sizing a Control Valve in Liquid Water Application	56
Example Case 3: Sizing a Control Valve in Vapor Hydrocarbon Application	60
Example Case 4: Sizing a Control Valve in Steam Application	65
Example Case 5: Sizing and ΔP calculating a Control Valve in water Application	69
REFEREENCES	73
SPECIFICATION DATA SHEET	74
Control Valve Data Sheet (Excel format)	75
CALCULATION SPREADSHEET	
Excel Format (British & SI unit)	
Sizing Spreadsheet for Liquid	75
Sizing Spreadsheet for Vapor	76
Example 1: Sizing a Control Valve in Liquid –Hydrocarbon	77
Example 2: Sizing a Control Valve in Liquid –Water	78
Example 3: Sizing a Control Valve in Vapor –Hydrocarbon	79
Example 4: Sizing a Control Valve in Vapor –Steam	80
Example Case 5: Sizing and ΔP calculating a Control Valve in Liquid – Water	81

International Association Of Certified Practicing Engineers	INSTRUMENTATION CONTROL VALVE SIZING AND MATERIAL SELECTION CPE LEVLE II TRAINING MODULE	Page 5 of 80
		Rev: 01
		August 2014

LIST OF TABLE

Table 1: Effect of the choice valve and actuator action for single port valves	18
Table 2: Equation Constants	36
Table 3: Calculation ΔP_{cv} considers $\sum \Delta P_{fric}$	37
Table 4: Typical F_i Factors	40

LIST OF FIGURE

Figure 1: Single port control valve	9
Figure 2: Single seat valve	10
Figure 3: Double port control valve	11
Figure 4: Double seat valve	12
Figure 5: Single seat design for mixing service in heat exchanger	13
Figure 6: Double seat design for diverging service in heat exchanger	13
Figure 7: Three way valve sevice	14
Figure 8: Butterfly control valve	15
Figure 9: Open position butterfly valve body	15
Figure 10: Direct acting diaphragm actuator	17
Figure 11: Reverse-acting diaphragm actuator	17
Figure 12: Flow characteristic curves	27
Figure 13: The shapes of the plug determine the flow characteristic	28
Figure 14: Installed flow characteristic for linear control valve installed in flow systems having different values of α	32

International Association Of Certified Practicing Engineers	INSTRUMENTATION CONTROL VALVE SIZING AND MATERIAL SELECTION	Page 6 of 80
		Rev: 01
		August 2014
CPE LEVEL II TRAINING MODULE		

Figure 15: Standard FCI Test Piping for C_v Measurement	34
Figure 16: Vena Contracta Illustration	38
Figure 17: Comparison of Pressure Profiles for High and Low Recovery Valves	38
Figure 18: Cavitation valve	39
Figure 19: Maximum flow rate occurring due to choked conditions	41

International Association Of Certified Practicing Engineers	INSTRUMENTATION CONTROL VALVE SIZING AND MATERIAL SELECTION CPE LEVLE II TRAINING MODULE	Page 7 of 80
		Rev: 01
		August 2014

INTRODUCTION

Scope

Hundreds or even thousands control loops are networked together in a process system plant to maintain the important process condition; such as pressure, fluid flow and level, temperatures, etc. During the process, each of these loops receives and internally creates disturbances that might affect process conditions. Hence sensors and transmitters are installed to send information about process condition changes to the controller, which can make any needed corrections actual to the desired set point by sending a signal to the final control element. Furthermore, a final control element is needed to provide the power and accuracy to control the flowing medium to the desired service conditions. The most common type of final control element in industrial process control system is control valve. The valve makes the change according to the signal from the controller, completing the loop.

Each type of control valve has a different flow characteristic, and its selection largely based on the type of the application process where it's installed into. Some common cases come along with this control valve sizing; an oversized control valve will spend an extra cost and introduce some difficulties in controlling the low flow rates, while an undersized valve might not be able to handle the maximum capacity of the process flow.

There are many available guidelines developed to aid engineers in selecting and sizing the valves, but mostly these guidelines are developed by certain companies and might only be suitable for the application of the valves provided by their own companies. Hence, it is important to obtain a general understanding of control valve sizing and selection first. Later, whenever changes are needed in a process system, this basic knowledge is still applicable. This guideline is made to provide that fundamental knowledge and a step by step guideline; which is applicable to properly select and size control valves in a correct manner.

Control valve supports the other devices which work together resulting in an ideal process condition. Hence, it is crucial to make some considerations before deciding the correct control valve sizing and selection. The selected valve has to be reasonable in cost, require minimum maintenance, use less energy, and be compatible with the control loop. Malfunction in control valve might cause process system does not work properly.

International Association Of Certified Practicing Engineers	INSTRUMENTATION CONTROL VALVE SIZING AND MATERIAL SELECTION CPE LEVLE II TRAINING MODULE	Page 8 of 80
		Rev: 01
		August 2014

Two basic steps to determine the control valve to be used are control valve selection and control valve sizing. Selection of control valve includes material selection and control valve type selection. Some commonly used materials are briefly mentioned in the general design consideration section. Different types of control valve actuator together with their advantages and disadvantages are also explained as well in this section.

This design guideline also covers what is needed is a method based on sound, credible principles. This design guideline introduce such a method for determining the optimum control valve pressure drop, balancing the need to providing enough pressure drop to achive control with the need to conserve energy.

Sizing the valve should not be done just by entering the numbers into formulas. It requires good understanding of theories behind the numbers. Any limiting or adverse conditions; such as flashing, cavitation, and choked flow need to be considered in design calculation. Their relation for valve sizing is explained in this guideline. Besides, two different types of fluid (liquids and gasses) would result in different calculation which is also included in this guideline. The calculation spreadsheet is also attached in the end of this guideline to make an engineer easy to follow the step by step calculation.

International Association Of Certified Practicing Engineers	INSTRUMENTATION CONTROL VALVE SIZING AND MATERIAL SELECTION CPE LEVLE II TRAINING MODULE	Page 9 of 80
		Rev: 01
		August 2014

INTRODUCTION

General Design Consideration

A common control valves consist of two parts: the control valve body and control valve actuator. Control valve body is the housing which is contained the flowing medium. It provides inlet and outlet connections; and a movable restrictor which varies the fluid flow as it opens and closes the port. The other term, an actuator, is part of control valve which causes the valve stem to move by providing the force it's needed.

I. Control Valve Body

Selection of a control valve body assembly requires particular consideration to provide the best available combination of valve body style, material, and trim construction design for the intended service. Capacity requirements and system operating pressure ranges also must be considered in selecting a control valve to ensure satisfactory operation without undue initial expense.

The body of a control valve will regulate the fluid flow as the position of the valve is changed by the actuator. Therefore, it is very important for the valve body to be able to permit actuator thrust transmission, resist chemical and physical effects from the process, and easily flange up with the adjacent piping connections. All the criteria mentioned above must be fulfilled without any external leaking. Most control valves are designed as a globe valve (linear), but other configurations such as ball and butterfly styles (rotary) are available based on the review of the engineering application. These are valve types which have linear and rotary motion, their limitations and capabilities are discussed and their more normal applications are covered

A. Linear Motion Valves

These valve types are divided to be three notes; there are single port valve, double port valve and three-way valve which should be considered for design.

International Association Of Certified Practicing Engineers	INSTRUMENTATION CONTROL VALVE SIZING AND MATERIAL SELECTION CPE LEVEL II TRAINING MODULE	Page 10 of 80
		Rev: 01
		August 2014

1. Single Port Valve Body

The most common control valve body style is single ported as shown in Figure 1, which has widely used in process control applications, particularly in sizes NPS (Nominal Pipe Size) 1 through NPS 4. Normal flow direction is most often flow-up through the seat ring. Single ported valves are available in various forms, such as globe, angle, bar stock, forged and split constructions.

Since high pressure fluid is normally loading the entire area of the port, the unbalance force created must be considered in selecting actuators for single ported control valve bodies. Single ported valves are known to work well in small sizes but it can often be used in 4 inch to 8 inch sizes with high thrust actuators. Many modern single ported valve bodies use cage style construction to retain the seat ring, provide guiding to the valve plug, and means for establishing a particular flow characteristic.

Cage style trim offers advantages in ease of maintenance and flexibility in changing the cages to alter valve flow characteristics. Cage style single seated valve bodies can also be easily modified by change of trim parts to provide reduced capacity flow, noise attenuation, or reduction or elimination of cavitations.

Port guided single port valve bodies :

- Usually limited to 150 psi (10 bar) maximum pressure drop.
- Susceptible to velocity-induced vibration.
- Typically provided with screwed in seat rings which might be difficult to remove after use.

These valves are generally specified for applications with stringent shutoff requirements. Metal to metal seating surfaces or “soft seating” with nitrile or other elastomeric materials forming the seal, can handle most service requirements^[3].

International Association Of Certified Practicing Engineers	INSTRUMENTATION CONTROL VALVE SIZING AND MATERIAL SELECTION	Page 11 of 80
		Rev: 01
	CPE LEVEL II TRAINING MODULE	August 2014

1.1 *Conventional Single Seat Valve*

The single seat design is used for small size might under one inch orifice in order to reduce forces sufficiently, so that normal machining tolerances to give suitable rangeability, characteristic and leakage are not considered needs.

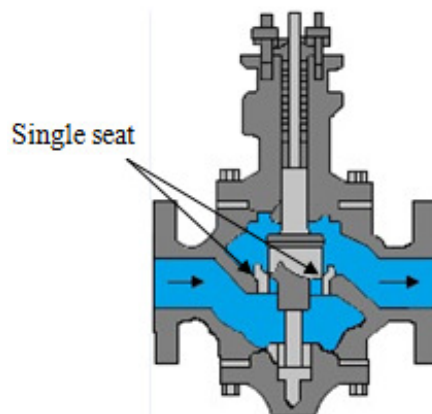

Figure 2: single seat valve

A single seat valve should be specified than double seat valve when a tight shut-off, such as on a furnace fuel cut-off valve is required, because commonly, the leakage can be easier expected for double seat valve. The forces required to shut a single seat globe valve increase considerably with valve size. Unbalanced standard single seat valves are designed with a balancing mechanism to reduce the closing force necessary, especially on valves operating with large differential pressures, may require a piston type actuator.

International Association Of Certified Practicing Engineers	INSTRUMENTATION CONTROL VALVE SIZING AND MATERIAL SELECTION	Page 12 of 80
		Rev: 01
		August 2014
CPE LEVEL II TRAINING MODULE		

2. Double Port Valve Body

Double port valve is a special trim design used to fill the same purpose as pressure balanced trim: to reduce the effect of the process forces on the plug, thereby lowering the thrust requirement and allowing the use of smaller actuators. Flow is directed by the inlet port to the body gallery and the trim, which features two seats and a single plug that features two plug heads, one above the other as shown in picture 5^[1]. The control valve body in the picture is assembled for push down to open valve plug action. Double ported designs are typically used in refineries on highly viscous fluids or where there is a concern about dirt, contaminants, or process deposits on the trim.

Port Guided Double Ported Valve Bodies :

- Dynamic force on plug tends to be balanced as flow tends to open one port and close the other.
- Bodies normally have higher capacity than single ported valves of the same line size.
- Many double-ported bodies reverse, so the valve plug can be installed as either push-down-to-open or push-down-to-close.
- Port guided valve plugs are often used for on-off or low pressure throttling service. Top-and-bottom guided valve plugs furnish stable operation for severe service conditions^[3].

International Association Of Certified Practicing Engineers	INSTRUMENTATION CONTROL VALVE SIZING AND MATERIAL SELECTION	Page 13 of 80
		Rev: 01
	CPE LEVEL II TRAINING MODULE	August 2014

2.1 Conventional Double Seat Valve

Since a larger valve, having a larger orifice, is used to pass greater volumes of the medium, then the force that the actuator must develop in order to close the valve will also increase. Where very large capacities must be passed using large valves, or where very high differential pressures exist, the point will be reached where it becomes impractical to provide sufficient force to close a conventional single seat valve. In such condition, the basic solution to this problem is the double seat valve to achieve an approximately balanced design.

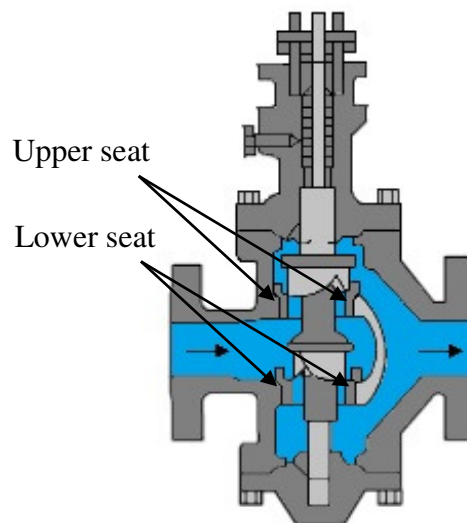

Figure 4 : double seat valve

Not only can the valve seats be kept smaller (since there are two of them) but also, the forces are partially balanced. This means that although the differential pressure is trying to keep the top valve plug off its seat it is also trying to push down and close the lower valve plug. Called balanced because most forces on plug at top seat are balanced by similar and opposite forces at bottom seat.

International Association Of Certified Practicing Engineers	INSTRUMENTATION CONTROL VALVE SIZING AND MATERIAL SELECTION	Page 14 of 80
		Rev: 01
	CPE LEVEL II TRAINING MODULE	August 2014

3. Three Way Valve Body

Three-way valves have two designs; double seated valve and single seated valve. Each of design has specific application. Double seated usually is used for diverging (flow-splitting), where as single seated is used for mixing (flow-mixing) service. These valve bodies are best designs use cage-style trim for positive valve plug guiding and ease of maintenance. Three-way valves are often found in refineries and chemical plants is around heat exchanger to control heat transferred, as shown in figure 5 and 6.

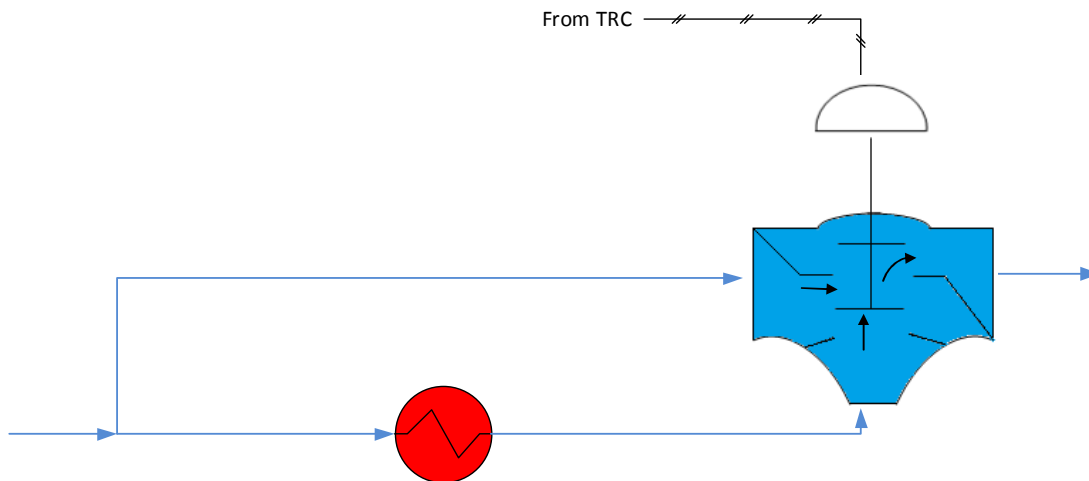

Figure 5: single seat design for mixing service in heat exchanger

International Association Of Certified Practicing Engineers	INSTRUMENTATION CONTROL VALVE SIZING AND MATERIAL SELECTION	Page 15 of 80
		Rev: 01
	CPE LEVEL II TRAINING MODULE	August 2014

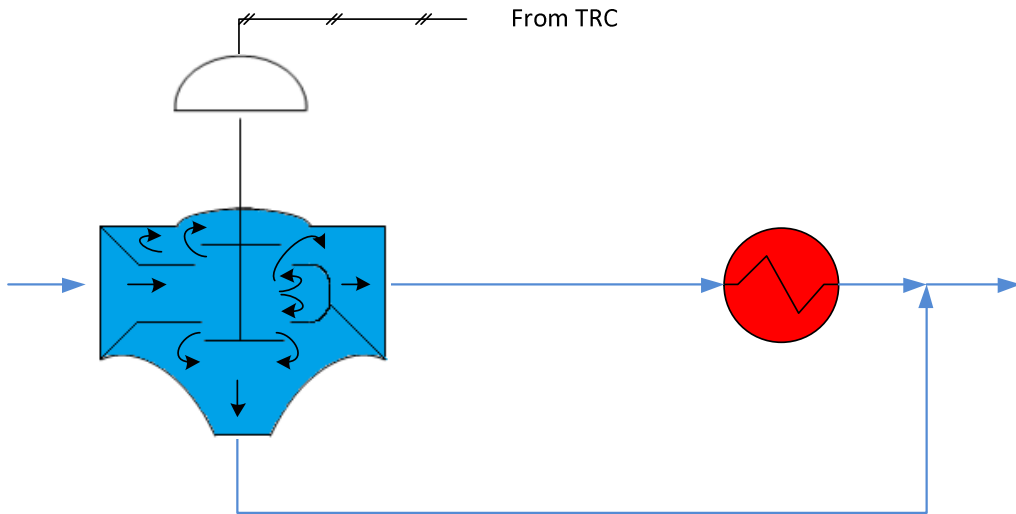

Figure 6: double seat design for diverging service in heat exchanger

Figure 7 explains the actuator pushes a disc or pair of valve plugs between two seats increasing or decreasing the flow through ports A and B in a corresponding manner.

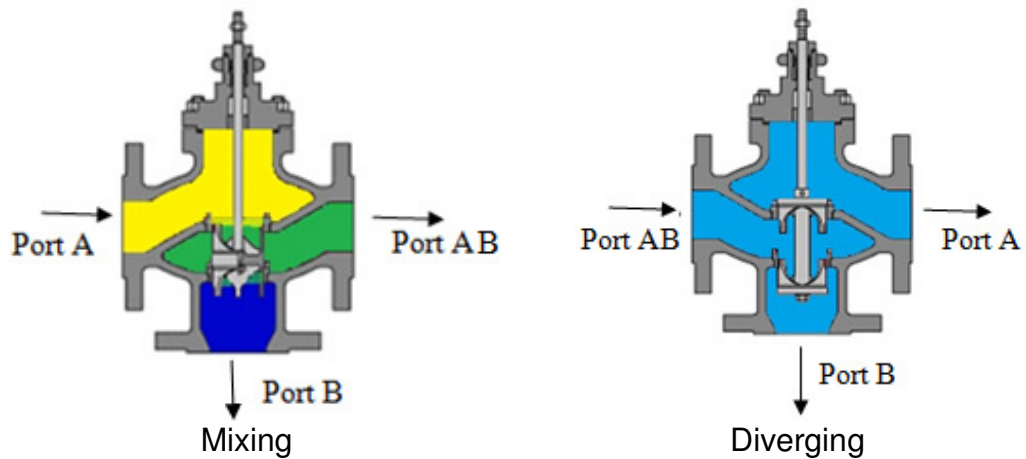

Figure 7: three way valve services

International Association Of Certified Practicing Engineers	INSTRUMENTATION CONTROL VALVE SIZING AND MATERIAL SELECTION	Page 16 of 80
		Rev: 01
	CPE LEVLE II TRAINING MODULE	August 2014

Each valve is shown in figure 5 and 6 its preferred placement, with the flow through each port inclining to open that port. There would be a harmful of the valve slamming onto its seat, with releasing line vibration, especially in the larger sizes, as a valve moves through its seat, the reduction in flow rate caused by this movement lowers the downstream pressure, so that increasing the pressure drop across the valve, if the valve were installed in such a placement that the flow would inclined to close the port.

B. Rotary Motion

Rotary control valves are direct through design to provide less resistance to flow and a higher pressure recovery. As a consequence, they provide a higher flow capacity with low pressure loss than equivalent size globe body valves that may make they appear more economical. Rotary control valves include all forms of butterfly valves as well as ball valves are most designed to be installed "sandwiched" between piping flanges. There is discussed about butterfly valve; another rotary body valve, ball valve is designed close such as butterfly valve for specific service conditions..

1. Butterfly Valve

The valve consists of a circular disc which is rotated in a trunnion bearings. Conventional contoured disks provide throttling control for up to 60° disk rotation. Patented, dynamically streamlined disks suit applications requiring 90° disk rotation^[5]. Butterfly control valve is shown in figure 8 and figure 9 explains open position butterfly valve body.

Figure 8: Butterfly Control Valve

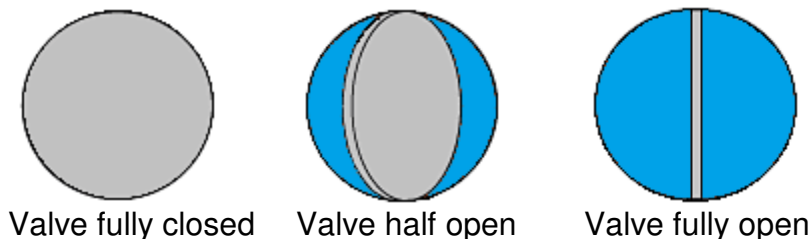

Figure 9: open position butterfly valve body

International Association Of Certified Practicing Engineers	INSTRUMENTATION CONTROL VALVE SIZING AND MATERIAL SELECTION	Page 17 of 80
		Rev: 01
		August 2014
CPE LEVEL II TRAINING MODULE		

The common services that often use butterfly valves are be in suction lines to centrifugal gas compressors and air blowers, outlet lines from water releasing drums, and as a replace for a large 3-way (two butterfly valves are needed) in gas lines through and by-passing heat exchangers.

Their rotation characteristic is between those of linear and equal percentage valves. General rotation of the disc does not require much torque but tight shut off usually requires a high torque. The torque is applied by a stem and is normally provided by a pneumatic piston, either by means of a lever or a rack and pinion^[2].

Control valve bodies may be screwed, flanged, or welded onto the flow line. Screw ends usually are threaded with American Standard female tapered pipe threads. The dimensions, design details, and pressure temperature ratings of flanged ends should be in accordance with American National Standards Institute (ANSI) specifications.

The most common material for control valve body construction is cast iron or carbon steel. Other materials such as chromium-molybdenum, stainless steel, bronze, monel, nickel and many other castable alloys can be used when the control valve is subjected to operate under extreme conditions, e.g. very high or very low temperature, or application under corrosive environment. The valve may also be constructed from solid bar or forged materials when cast valve bodies are not practical, particularly for small valves.

The construction material for control valve trim, i.e. those parts which must retain close machined tolerances for sealing, metering, or moving, must be selected with care. It must generally be more resistant to corrosion, erosion, galling, and distortion than the body material.

International Association Of Certified Practicing Engineers	INSTRUMENTATION CONTROL VALVE SIZING AND MATERIAL SELECTION	Page 18 of 80
		Rev: 01
		August 2014
CPE LEVLE II TRAINING MODULE		

II. Control Valve Actuator

Most common control valve actuators are pneumatically operated but other means of operation such as electric, hydraulic and manual actuators are also available. The operation mechanism of an actuator can be direct acting (Figure 10) or reverse acting (Figure 11). The spring and diaphragm pneumatic actuator is most popular due to its dependability and simplicity of design. Pneumatically operated piston actuators provide integral positioner capability and high stem force output for demanding service conditions. Adaptations of both spring and diaphragm and pneumatic piston actuators are available for direct installation on rotary shaft control valves.⁽⁵⁾

The choice between direct acting and reverse acting pneumatic controls depends on what position the valve should back to in the event of failure of the compressed air supply. This choice depends upon the environment of the application and safety requirements. It makes sense for steam valves to close on air failure, and cooling valves to open on air failure.

Table 1: Effect of the choice valve and actuator action for single port valves

Single port valves				
Actuator action	Direct	Reverse	Reverse	Direct
Valve action	Direct	Reverse	Direct	Reverse
On air failure	Valve opens		Valve closes	

Electric and electro-hydraulic actuators are more complex and more expensive than pneumatic actuators. This is due to these types of actuators offer advantages where no air supply source is available, where low ambient temperatures could freeze condensed water in pneumatic supply lines, or where unusually large stem forces are needed. A brief summary regarding the design and characteristics of the actuators are given as follows^[3].

International Association Of Certified Practicing Engineers	INSTRUMENTATION CONTROL VALVE SIZING AND MATERIAL SELECTION	Page 20 of 80
		Rev: 01
		August 2014
CPE LEVLE II TRAINING MODULE		

I) Diaphragm Actuators

Pneumatically operated, using low-pressure air supply from controller, positioner, or other source.

Various styles include:

- Direct acting - increasing air pressure pushes down diaphragm and extends actuator stem;
- Reverse acting - increasing air pressure pushes up diaphragm and retracts actuator stem;
- Reversible - some small sized actuators can be assembled for either direct or reverse action ;
- Direct acting unit for rotary valves - increasing air pressure pushes down on diaphragm, which may either open or close the valve, depending on orientation of the actuator lever on the valve shaft.

Net output thrust of diaphragm actuators is the difference between diaphragm force and opposing spring force. Molded diaphragms are used to provide linear performance and increased travels. Size is dictated by output thrust required and supply air pressure available. It is simple, dependable, and economical.

II) Piston Actuators

Pneumatically operated using high pressure plant air to 150 psig, often eliminating the need for supply pressure regulator. Furnish maximum thrust output and fast response. It is easily reversible by changing action of the integral valve positioner. Best designs are double acting to give maximum force in both directions. Various accessories can be incorporated to position the actuator piston in the event of supply pressure failure. These include spring return units, pneumatic trip valves and lock up systems.

Also available are hydraulic snubbers, handwheels, and units without yokes, which can be used to operate butterfly valves, louvers, and similar industrial equipment. Other

International Association Of Certified Practicing Engineers	INSTRUMENTATION CONTROL VALVE SIZING AND MATERIAL SELECTION CPE LEVEL II TRAINING MODULE	Page 21 of 80
		Rev: 01
		August 2014

versions for service on rotary shaft control valves include a sliding seal in the lower end of the cylinder. This permits the actuator stem to move laterally as well as up and down without leakage of cylinder pressure. (This feature permits direct connection of the actuator stem to the actuator lever mounted on the rotary valve shaft, thereby eliminating much of the lost motion common to jointed leakage.)

III) Electro Hydraulic Actuators

Requiring only electrical power to the motor and an electrical input signal from the controller. It is ideal for isolated locations where pneumatic supply pressure is not available but where precise control of valve plug position is needed. Units are normally reversible by making minor adjustments and are usually self-contained, including motor, pump, and double-acting hydraulically operated piston within a weatherproof or explosion proof casing.

IV) Manual Actuators

Manual actuators is useful where automatic control is not required, but where ease of operation and good throttling control is still necessary. It is often used to actuate the bypass valve in a three valve bypass loop around control valves for manual control of the process during maintenance or shutdown of the automatic system. It is available in various sizes for both globe style valves and rotary shaft valves. It is dial indicating devices available for some models to permit accurate repositioning of the valve plug or disc and much less expensive than automatic actuators.

International Association Of Certified Practicing Engineers	INSTRUMENTATION CONTROL VALVE SIZING AND MATERIAL SELECTION CPE LEVLE II TRAINING MODULE	Page 22 of 80
		Rev: 01
		August 2014

DEFINITIONS

Capacity – Rate of flow through a valve under stated conditions.

Choked flow - Condition at constant inlet pressure when no increase in flow rate is achieved for a decrease in downstream pressure.

Dead Band ⁽⁴⁾- Is the range which an input can be varied without initiating observable response. (By referred to the amount of the diaphragm pressure it can be changed without initiating valve stem movement in a diaphragm actuated control valve. It is usually expressed as a percent of diaphragm pressure span.)

Diaphragm Pressure Span – Difference between the high and low values of the diaphragm pressure range. This may be stated as an inherent or installed characteristic.

Double –Acting Actuator – An actuator capable of operating in either direction, extending or retracting the actuator stem as dictated by the fluid pressure acting upon it.

Dynamic Unbalance - The net force produced on the valve plug in any stated open position by the fluid pressure acting upon it.

Effective Area - Part of the diaphragm area which is effective in producing a stem force in a diaphragm actuator. (The effective area of a diaphragm may change as it is stroked, usually being a maximum at the end of the travel range. Molded diaphragms have less change in effective area than flat sheet diaphragms, and are recommended.)

Equal Percentage Flow Characteristic – An inherent flow characteristic which produces equal percentage of changes in the existing flow for equal increments of rated travel. (Increasing sensitivity)

Fail-Closed - A condition wherein the valve port remains closed should the actuating power fail.

Fail-Open - A condition wherein the valve port remains open should the actuating power fail.

International Association Of Certified Practicing Engineers	INSTRUMENTATION CONTROL VALVE SIZING AND MATERIAL SELECTION CPE LEVEL II TRAINING MODULE	Page 23 of 80
		Rev: 01
		August 2014

Fail-Safe - An actuator which will fully close, fully open, or remain in the fixed position upon loss of power supply. (May require additional auxiliary controls to be connected to the actuator)

Flashing - Condition where the cavitation vapor persists downstream of the region where bubble collapse normally occurs, ie, the cavitation process stops before the completion of the second stage defined in the above "Cavitation".

Flow Characteristic - Relationship between the flow of fluid through the valve and the percent of rated travel as the latter is varied from 0 – 100 percent. This term should always be designated as either inherent flow characteristic or installed flow characteristic.

High Recovery Valve - A valve design that dissipates relatively little flow stream energy due to streamlined internal contours and minimal flow turbulence. (Straight-through flow valves, such as rotary-shaft ball valves, are typically high-recovery valves.)

Inherent Diaphragm Pressure Range - The high and low values of pressure applied to the diaphragm to produce rated valve plug travel with atmospheric pressure in the valve body. (This range is often referred to as a "bench set" range since it will be the range over which the valve will stroke when it is set on the work bench.)

Inherent Flow Characteristic - Flow characteristic when constant pressure drop is maintained across the valve.

Inherent Rangeability - Ratio of maximum to minimum flow within which the deviation from the specified inherent flow characteristic does not exceed some stated limit. (A control valve that still does a good job of controlling when increases to 100 times the minimum controllable flow has a rangeability of 100 to 1. Rangeability might also be expressed as the ratio of the maximum to minimum controllable flow coefficients.)

Installed Diaphragm Pressure Range - The high and low values of pressure applied to the diaphragm to produce rated travel with stated conditions in the valve body. (It is because of the forces acting on the valve plug that the inherent diaphragm pressure range can differ from the installed diaphragm pressure range.)

International Association Of Certified Practicing Engineers	INSTRUMENTATION CONTROL VALVE SIZING AND MATERIAL SELECTION	Page 24 of 80
		Rev: 01
	CPE LEVLE II TRAINING MODULE	August 2014

Installed Flow Characteristic - Flow characteristic when pressure drop across the valve varies as dictated by flow and related conditions in the system in which the valve is installed.

Leakage - Quantity of fluid passing through an assembled valve when the valve is in the closed position under stated closure forces, with pressure differential and pressure as specified.

Linear Flow Characteristic - An inherent flow characteristic which can be represented ideally by a straight line on a rectangular plot of flow versus percent rated travel. (Equal increments of travel yield equal increments of flow at a constant pressure drop.)

Low-Recovery Valve - A valve design that dissipates a considerable amount of flow stream energy due to turbulence created by the contours of the flow path. This results into a lower pressure recovery across the vena contracta and hence the valve will have a larger pressure drop. (Conventional globe-style valves generally have low pressure recovery capability.)

Normally Closed Control Valve - A control valve which closes when the diaphragm pressure is reduced to atmospheric.

Normally Open Control Valve - A control valve which opens when the diaphragm pressure is reduced to atmospheric.

Push-Down-to-Close Construction ⁽²⁾- A globe-style valve construction in which the valve plug is located between the actuator and the seat ring. The valve closes when the extension of the actuator stem moves the valve plug toward the seat ring, finally closing the valve. This mechanism is also called Direct Acting. (For rotary-shaft, linear extension of the actuator stem moves the ball or disc toward the closed position.)

Push-Down-to-Open - A globe type valve construction in which the seat ring is located between the actuator and the valve plug. The valve opens when the extension of the actuator stem moves the valve plug away from the seat ring. This mechanism is also called Reverse Acting. (For rotary-shaft valve, linear extension of the actuator stem moves the ball or disc toward the open position.)

Quick Opening Flow Characteristic - An inherent flow characteristic in which there is maximum flow with minimum travel. (Decreasing sensitivity)

International Association Of Certified Practicing Engineers	INSTRUMENTATION CONTROL VALVE SIZING AND MATERIAL SELECTION CPE LEVEL II TRAINING MODULE	Page 25 of 80
		Rev: 01
		August 2014

Rated C_v - The value of C_v at the rated full-open position.

Rated Travel - Linear movement of the valve plug from the closed position to the rated full-open position. (The rated full-open position refers to the maximum opening recommended by the manufacturer.)

Seat - The area of contact between the closure member and its mating surface that establishes valve shut-off.

Seat Load - The contact force between the seat and the valve plug. (In practice, the selection of an actuator for a given control valve will be based on how much force is required to overcome static, stem, and dynamic unbalance with an allowance made for seat load.)

Spring Rate - Force change per unit change in length. (In diaphragm control valves, the spring rate is usually stated in pounds force per inch compression.)

Static Unbalance - The net force produced on the valve plug in its closed position by the fluid pressure action upon it.

Stem Unbalance - The net force produced on the valve plug stem in any position by the fluid pressure action upon it.

Trim - The internal components of a valve that modulate the flow of the controlled fluid. In a globe valve body, trim would typically include closure member, seat ring, cage, stem, and stem pin.

Valve Flow Coefficient (C_v) - The amount of 60°F water in US gallons per minute that will flow through a valve with a one pound per square inch pressure drop.

Vena Contracta - The point where the pressure and the cross-sectional area of the flow stream is at its minimum, whereas the fluid velocity is at its highest level. (Normally occurs just down stream of the actual physical restriction in a control valve.)

International Association Of Certified Practicing Engineers	INSTRUMENTATION CONTROL VALVE SIZING AND MATERIAL SELECTION	Page 26 of 80
		Rev: 01
		August 2014

NOMENCLATURE

α	Ratio of valve head differential at max flow to zero flow
C_v	Valve sizing coefficient
d	Nominal valve size
D	Pipe internal diameter
F_d	Valve style modifier, dimensionless
F_k	Ratio of specific heats factor
F_L	Liquid pressure recovery factor
F_{LP}	Combined liquid pressure recovery and piping geometry factor of valve attached to fittings, dimensionless
F_R	Reynolds number factor
$F(x)$	Fraction open valve
S	Liquid specific gravity, dimensionless
S_g	Gas specific gravity, dimensionless
k	Ratio of specific heats, adiabatic index or isentropic exponent, dimensionless
M	Molecular weight, dimensionless
N	Numerical constant from Table 1
N_{Re}	Reynolds number, dimensionless
P_1	Upstream pressure (Absolute)
P_2	Downstream pressure (Absolute)
P_c	Critical pressure (Absolute)
P_v	Vapor pressure (Absolute) of liquid at inlet temperature
ΔP	Pressure drop across the valve ($P_1 - P_2$)
$\Delta P_{critical}$	Maximum allowable pressure drop across the valve for design purpose
ΔP_s	Pressure drop across the valve for sizing
ΔP_{cv}	Pressure drop across the valve from centrifugal pump discharge
Q	Volumetric flow rate
Q_{max}	Maximum flow rate (choked flow conditions) at given upstream condition
r_c	Liquid critical pressure ratio factor, dimensionless
T_1	Upstream temperature (Absolute, T or R)
W	Mass flow rate
x	Ratio between pressure drop across the valve and inlet pressure, dimensionless
x_T	Rated pressure drop ratio factor, dimensionless

International Association Of Certified Practicing Engineers	INSTRUMENTATION CONTROL VALVE SIZING AND MATERIAL SELECTION CPE LEVEL II TRAINING MODULE	Page 27 of 80
		Rev: 01
		August 2014

XTP	Rated pressure drop ratio factor for valves attached to fittings, dimensionless
Y	Expansion factor, dimensionless
ρ	Density
z	Compressibility factor, dimensionless
γ_1	Density at inlet conditions
u	Kinematic viscosity, centistokes